



Typical Features

- ◆ Wide input voltage range 4:1
- ◆ Efficiency up to 89%
- ◆ Low no-load power consumption
- ◆ Operating Temperature from -40°C to +105°C
- ◆ High isolation voltage 3000VAC(input-output) & 2100VAC(input-case)
- ◆ Input under voltage protection, output over voltage, short circuit, over current and over temp protections
- ◆ Standard 1/4 brick size

Conform to CE

ZCD75-110S05A is a high-reliability DC-DC converter specially designed for the railway field. It's rated input voltage 110VDC (full range from 43V to 160VDC), single regulated output 5V/75W without minimum load limit. It has the advantages of high isolation voltage, Max operating temperature up to 105°C, with input under-voltage protection, output over-current, over-voltage, over-temperature and short circuit protections, input remote control, output voltage distal end compensation and Trim, etc. It is compliant with the railway standard EN50155 and widely used in the railway systems related equipment.

Typical Product List

Part no	Input voltage range (VDC)	Output power (W)	Output voltage (VDC)	Output current (A)	Ripple & Noise (mVp-p)	Full load efficiency (%) Min/Typ.	Note
ZCD75-110S05AC	43-160	75	5	15	100	87/89	Standard Positive logic
ZCD75-110S05AN							Standard Negative logic
ZCD75-110S05AC-H							Heatsink Positive logic
ZCD75-110S05AN-H							Heatsink Negative logic

Note: The output power could be derated linearly when the input is within the range of 43-66V. The maximum output power is 50W at input 43Vdc.

Input Specifications

Item	Operating conditions	Min.	Typ.	Max.	Unit
Max input current	43V input voltage, full load output	--	--	1.8	A
No load input current	Rated input voltage	--	--	10	mA
Input Inrush voltage (1sec. max.)	The unit could be permanently damaged by input over this Voltage	-0.7	--	185	VDC
Start-up voltage		--	--	43	
Input under voltage protection	No-load test (over current protection will work in advance at full load)	--	--	40	
Remote Control (CNT)	Positive logic: CNT no connection or connect to 3.5-15V to turn on, connect to 0-1.2V to shut off				Reference voltage - Vin
	Negative logic: CNT no connection or connect to 3.5-15V to shut off, connect to 0-1.2V to turn on				

Output Specifications

Item	Operating conditions	Min.	Typ.	Max.	Unit
Output Voltage Accuracy	Rated input voltage, 10%-100% load	--	±0.2	±1.0	%
Line Regulation	Full load, input voltage from low to high	--	±0.1	±0.2	
Load Regulation	Rated input voltage, 10%-100% load	--	±0.1	±0.2	
Transient recovery time	25% load step change (step rate 1A/50uS)	--	200	250	uS
Transient Response Deviation		-5	--	+5	%
Temperature Drift Coefficient	Full load	-0.02	--	+0.02	%/°C
Ripple & Noise	20M bandwidth, external capacitor above 220uF	--	80	100	mVp-p
Output voltage adjustment (TRIM)		-20	--	+10	%
Output voltage distal end compensation (Sense)		--	--	105	%
Over temp protection	Maximum temperature on the metal board surface	105	115	125	°C
Over voltage protection		120	--	130	%
Over current protection		16	--	20	A
Short circuit protection		Hiccup, continuous, self-recovery			

General Specifications

Item	Operating conditions		Min.	Typ.	Max.	Unit
Isolation Voltage	I/P-O/P	Test 1min, leakage current < 3mA	--	--	3000	VAC
	I/P-Case	Test 1min, leakage current < 3mA	--	--	2100	VAC
	O/P-Case	Test 1min, leakage current < 3mA	--	--	500	VAC
Insulation resistance	I/P-O/P	@ 500VDC	--	--	10	MΩ
Switching frequency			--	150	--	KHz
MTBF			150	--	--	K hours

Environmental characteristics

Item	Operating conditions	Min.	Typ.	Max.	Unit
Operating Temperature	Refer to the temperature derating curve	-40	--	+105	°C
Storage Humidity	No condensing	5	--	95	%RH
Storage Temperature		-40	--	+125	°C
Pin Soldering temperature	1.5mm from the case, the soldering time< 1.5S	--	--	+350	
Cooling requirements		EN60068-2-1			
Dry heat requirement		EN60068-2-2			
Damp heat requirement		EN60068-2-30			
Shock and vibration		IEC/EN 61373 C1/Body Mounted Class B			

EMC Performances (EN50155)

EMI	CE	EN50121-3-2	150kHz-500kHz 79dBuV	
		EN55016-2-1	500kHz-30MHz 73dBuV	
	RE	EN50121-3-2	30MHz-230MHz 40dBuV/m at 10m	
		EN55016-2-1	230MHz-1GHz 47dBuV/m at 10m	
EMS	ESD	EN50121-3-2	Contact ±6KV / Air ±8KV	perf. Criteria A
	RS	EN50121-3-2	10V/m	perf. Criteria A
	EFT	EN50121-3-2	±2kV 5/50ns 5kHz	perf. Criteria A
	Surge	EN50121-3-2	Line to line ± 1KV (42Ω, 0.5μF)	perf. Criteria A
	CS	EN50121-3-2	0.15MHz-80MHz 10 Vr.m.s	perf. Criteria A

Physical Characteristics

Case Materials	Metal bottom shell + plastic case in black, flame class UL94 V-0
Heat sink	Dimension 60.4x39.0x15.0 mm, weight 52g, aluminum alloy, anodized black
Cooling method H	Conduction cooling or forced air cooling
Product Weight	Standard 72g, with heatsink 125g

Mechanical Dimensions and Pin-Out description

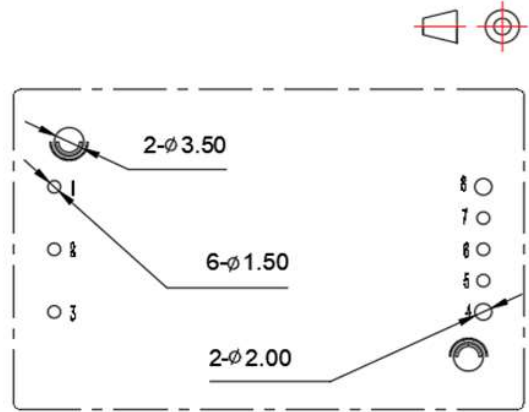
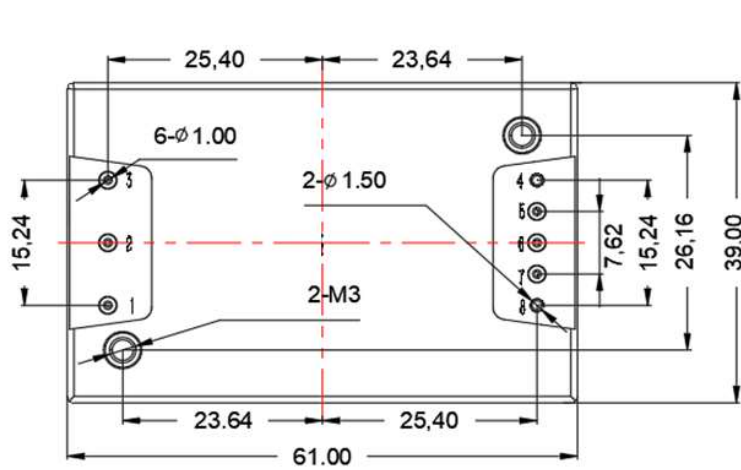

Recommended PCB holes size

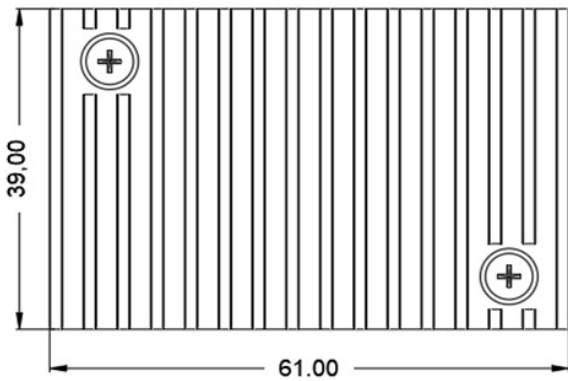
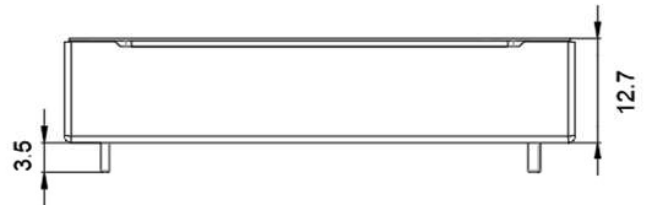
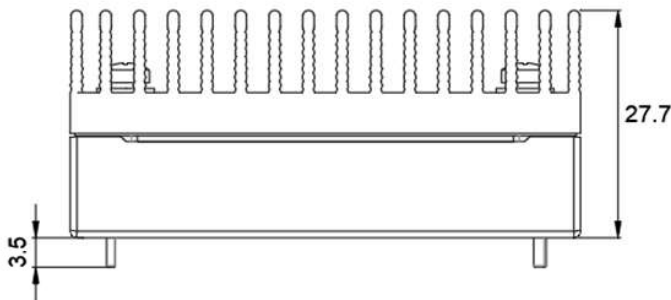

Standard+Heatsink
61.0x39.0x27.7mm

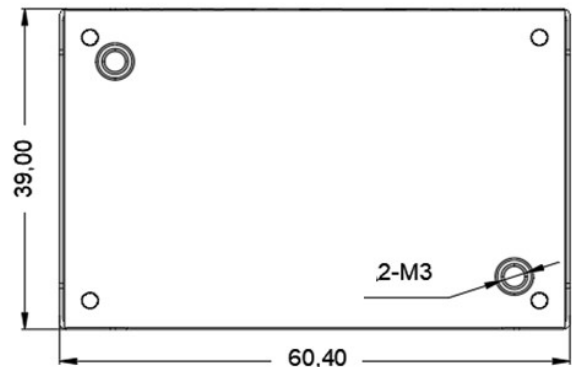

Standard
60.4x39.0x12.7mm

Note:
Unit: mm
Pin 1,2,3,5,6,7 diameter: 1.00
Pin 4,8 diameter: 1.50
Tolerance: X.X ±0.50mm, X.XX ±0.10mm
Screwing torque: 0.4N.m Max

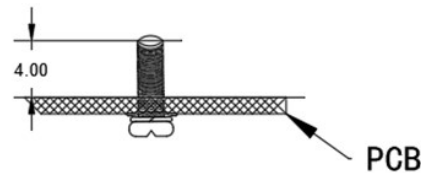

No.	1	2	3	4	5	6	7	8
Pin out	Vin+	CNT	Vin-	Vout-	-Sense	TRIM	+Sense	Vout+
Description	Input V+	Remote Control	Input V-	Output V-	Output distal end compensation S-	Output Voltage Trim	Output distal end compensation S+	Output V+

Product Performance Curve

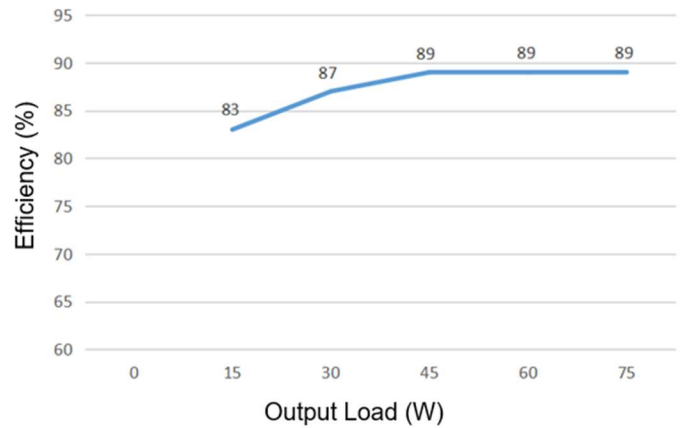
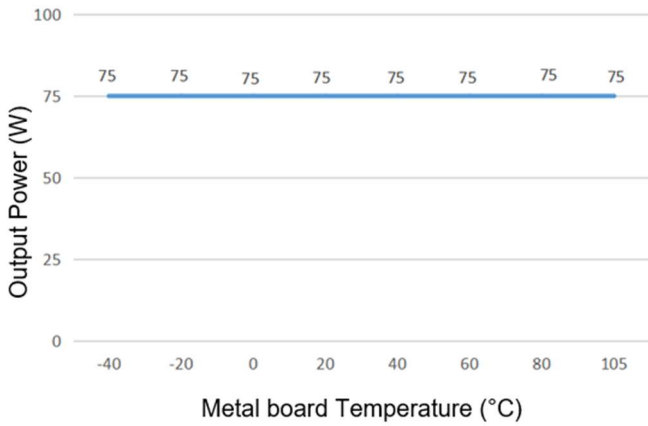

Note:

- Both the output power and efficiency in both curves are tested with typical values.
- The temperature derating curve is tested at Aipu laboratory test conditions. It is recommended to keep the temperature of the case not more than 100 °C while the converter operates at the rated load range for customer application.

Recommended circuits for application

1. Ripple and Noise

All this series DC/DC converters will be tested according to the circuit below before shipping.

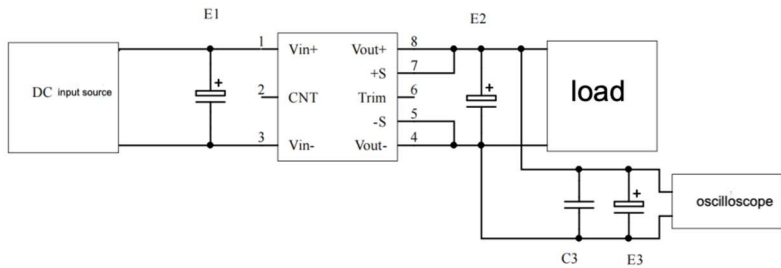

Output Voltage	Capacitor value			
	E1 (μF)	E2 (μF)	C1 (μF)	E3 (μF)
3.3VDC	100	1000	1	10
5VDC		680		
12VDC		220		
.....				
48VDC				
.....				
110VDC	68	68		

2. Recommended application circuit

If this circuit recommended is not adopted, please connect an electrolytic capacitor $\geq 100 \mu\text{F}$ in parallel at the input to suppress the possible surge voltage at the input.

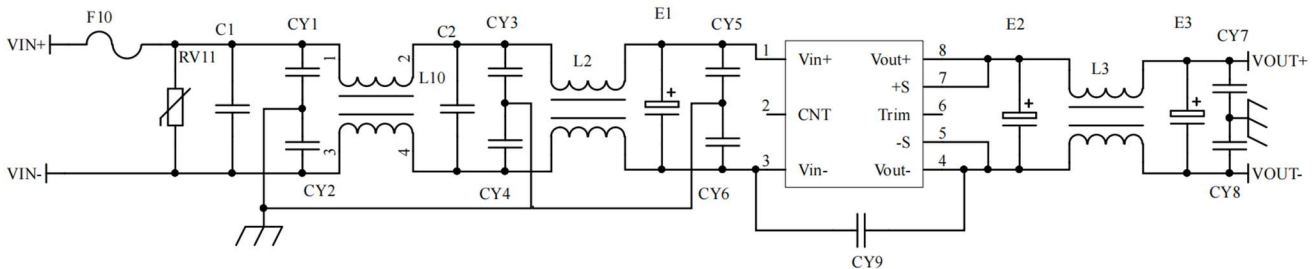

F1	3.15A/250V Time-delay fuse
RV1	10D 200V Varistor
C1,C2	474/250V Polyester Film Capacitor
CY1,CY2,CY3,CY4,CY5,CY6	102/250Vac Y2 capacitor
CY7,CY8	103/2KV Ceramic Capacitor
CY9	471/250Vac Y1 capacitor
E1	82μF/200V Electrolytic Capacitor
E2, E3	220μf/6.3V Low ESR Capacitor
L1,L2	$\geq 5\text{mH}$, temperature rise less than 25°K@1.8A
L3	$\geq 100\text{nH}$, temperature rise less than 25°K@15A

3. Remote control (CNT) application

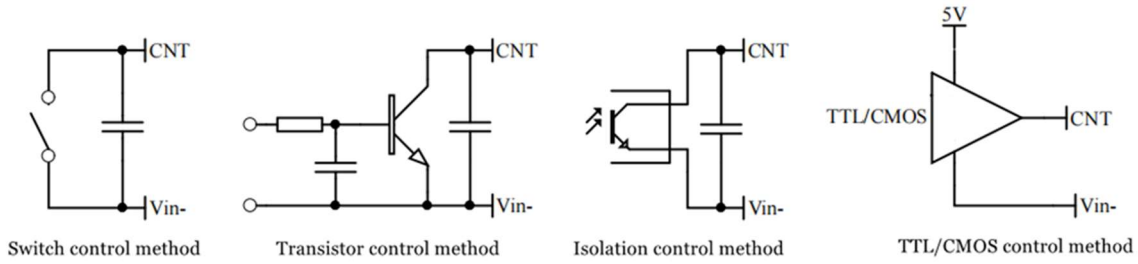

4. Application for Sense

1) With NO distal end compensation

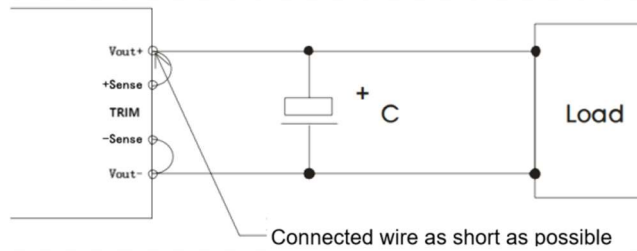

- Notes:
1. Vout+ & Sense+, Vout- & Sense- should be shorted when distal compensation is not needed
 2. The lead wire between Vout+ and Sense+, Vout- and Sense- should be as short as possible, and close to the pins, or else the output may be unstable.

2) With distal end compensation

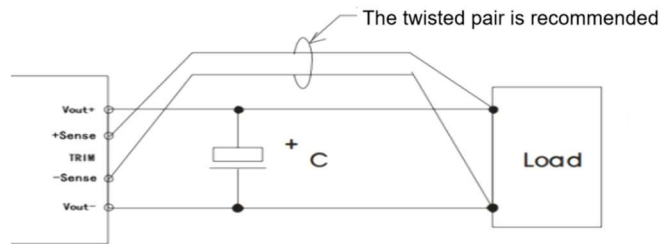

- Notes:
1. The output voltage may be unstable if the compensation cables are too long.
 2. Twisted pair or shielded cables are recommended, the cable length should be as short as possible.
 3. Wide copper path on PCB or thick lead wires between the power supply and the load should be used to achieve the line voltage drop <0.3V. The target is to keep output voltage within the specified range.
 4. The leads wire resistance may create the output voltage oscillation or larger ripples. Please verify it before to use.

5. TRIM & TRIM resistance calculation

The calculation of ΔU and R_{up} & R_{down} :

$$R_{up} = 12.75 / (\Delta U - 5.1) \text{ (K}\Omega\text{)}$$

$$R_{down} = 10.2 * (3.75 - \Delta U) / (\Delta U - 5.1) \text{ (K}\Omega\text{)}$$

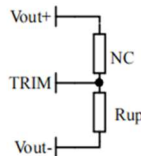

Voltage-up: Add R_{up} between Trim and Vout-

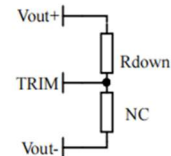

Voltage-down: Add R_{down} between Trim and Vout+

6. This product is not available for connection in parallel to increase the output power. Please contact Aipu technician for this kind of requirement.

Others

1. The product warranty period is two years. The failed product can be repaired/replaced free of charge if it operates at normal condition. A paid service shall be also provided if the product failed after operating under wrong or unreasonable conditions.
2. Aipupower can provide customization design and filter modules for matching, please contact our technician for details.

Guangzhou Aipu Electron Technology Co., Ltd

Address: Building 4, HEDY Park, No.63, Punan Road, Huangpu Dist, Guangzhou, China.

Tel: 86-20-84206763 Fax: 86-20-84206762 HOTLINE: 400-889-8821

E-mail: sales@aipu-elec.com Website: www.aipupower.com